

Composite dry sliding bushings, metric dimensions

Principal dimensions			Basic load ratings		Mass	Designation
d	D	B	dynamic C	static C0	kg	-
mm			kN			
40	44	40	125	390	0,078	PCM 404440 E

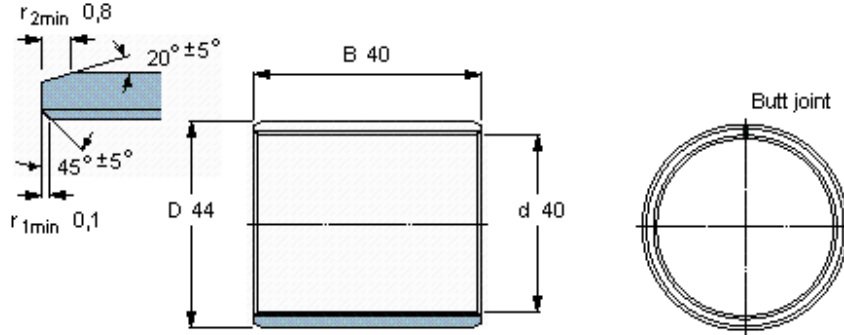

Specific load factor K 80
Material constant K_M 480